

ESCALA/SCALE 1:80

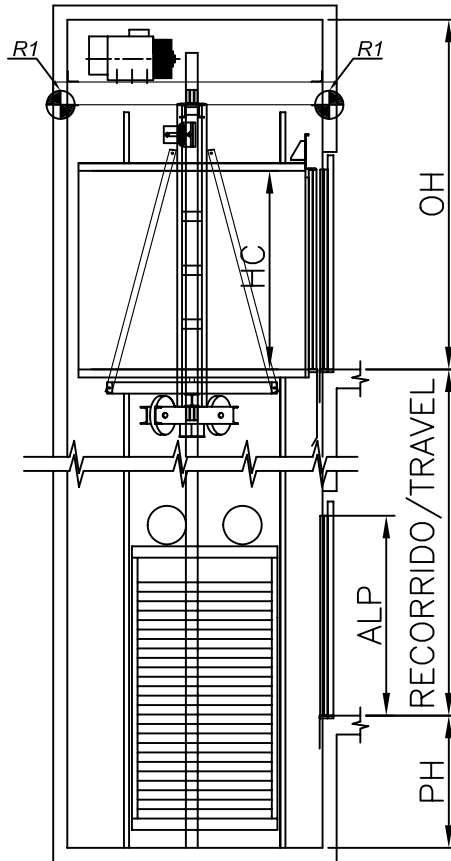

ESCALA/SCALE 1:40

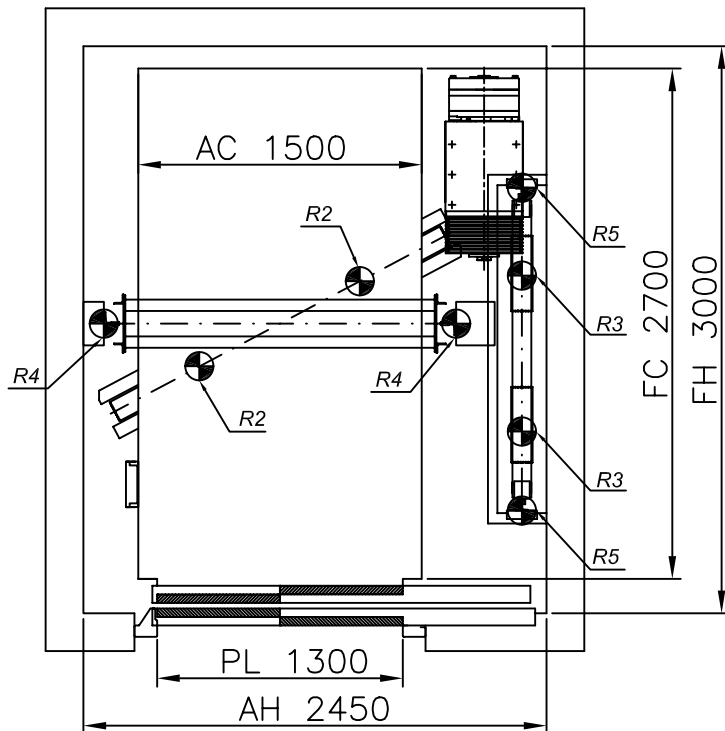

ACCIONES SOBRE EL HUECO

R1	CARGA SOBRE PARED / WALL LOAD	70000 N
R2	CARGA EN PUFFER CAB / CAR BUFFER LOAD	74180 N
R3	CARGA EN PUFFER CPSO / CTW BUFFER LOAD	54540 N
R4	CARGA EN GUÍA CAB / CAR GUIDE LOAD	42340 N
R5	CARGA EN GUÍA CPSO / CTW GUIDE LOAD	1650 N
	REACCION DE GUIAS Sx / GUIDES REACTIONS Sx	1470 N
	REACCION DE GUIAS Sy / GUIDES REACTIONS Sy	2800 N

MP2610 GO! "S"

2000 Kg	1 m/s
26 P.	GO!
FOSO/PIT	HUIDA/OVERHEAD
1400	3700



16 Kw

ESCALA/SCALE 1:80

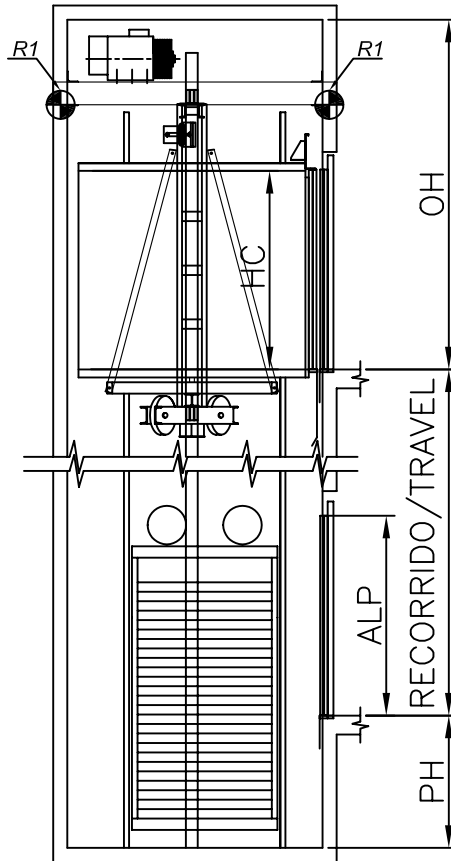

ESCALA/SCALE 1:40

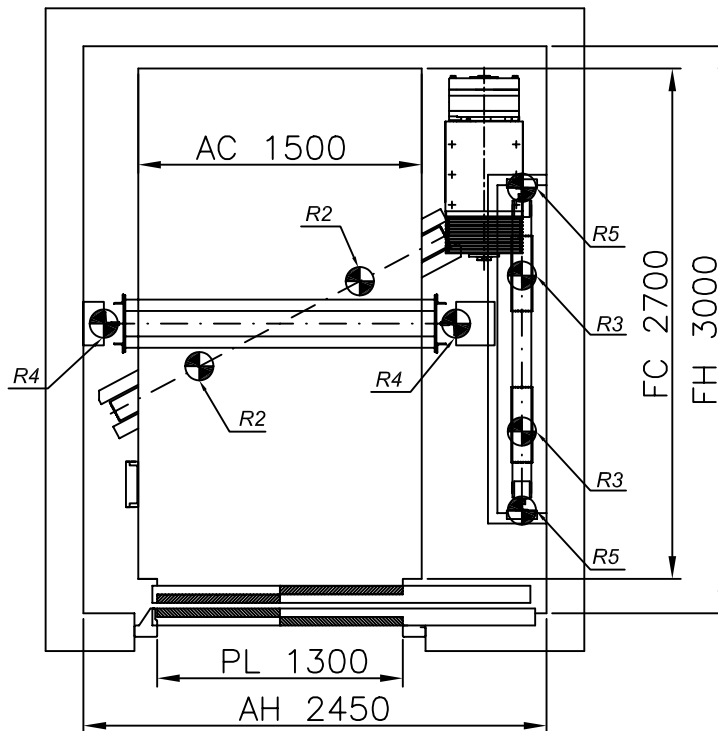

ACCIONES SOBRE EL HUECO

R1	CARGA SOBRE PARED / WALL LOAD	70000 N
R2	CARGA EN PUFFER CAB / CAR BUFFER LOAD	74180 N
R3	CARGA EN PUFFER CPSO / CTW BUFFER LOAD	54540 N
R4	CARGA EN GUÍA CAB / CAR GUIDE LOAD	42340 N
R5	CARGA EN GUÍA CPSO / CTW GUIDE LOAD	1650 N
	REACCION DE GUIAS Sx / GUIDES REACTIONS Sx	1470 N
	REACCION DE GUIAS Sy / GUIDES REACTIONS Sy	2800 N

MP2616 GO! "S"

2000 Kg	1.6 m/s
26 P.	GO!
FOSO/PIT	HUIDA/OVERHEAD
1500	3800



26 Kw